

MINIATURE K Series

Features

- Choice of current ratings up to 25 amps
- Choice of actuators
- Choice of terminals
- 3 contact arrangements
- Choice of operating force
- Long mechanical life
- Wiping contact action
- Snap over actuators
- Agency approved extended life versions

International Approved Versions

K Series switches, except 25A (KWS), are internationally approved. Switches with straight terminals may require insulated connectors for international approval.

Electrical Ratings

Switch Series	EN61058 Rating	UL1054 Rating	Electrical Life at Rated Load	
			According to VDE (Min. Operations)	According to UL (Min. Operations)
KWA/KWB	50mA, 28VDC	50mA, 28VDC	50,000	100,000
KWC/KWD	1(0.5)A, 250VAC	1.0A, 125/250VAC	50,000	100,000
KWE/KWF	3(1)A, 250VAC	3A, 1/10HP, 125/250VAC	50,000	100,000
KWG/KWH	6(2)A, 250VAC	5A, 1/4HP, 125/250VAC	50,000	100,000
KWJ/KWK	10(3)A, 250VAC	10A, 1/2HP, 125/250VAC	50,000	100,000
KWL	N/A	15.1A, 1/2HP, 125/250 VAC 5A, 125VAC Lamp Load (85°C only) 0.5A, 125VDC (85°C only) 0.25A, 250VDC (85°C only)	N/A	100,000
KWM	16(4)A, 250VAC	15.1A, 1/2HP, 125/250VAC 0.5A, 125VDC (85°C and 150°C only) 0.25A, 250VDC (85°C and 150°C only) 15.1A, 1/2HP, 125/250VAC (200°C only)	50,000	100,000
KWS	N/A	25A, 125/250VAC (85°C only) 1HP, 125VAC (85°C only) 2HP, 250VAC (85°C only)	N/A	100,000

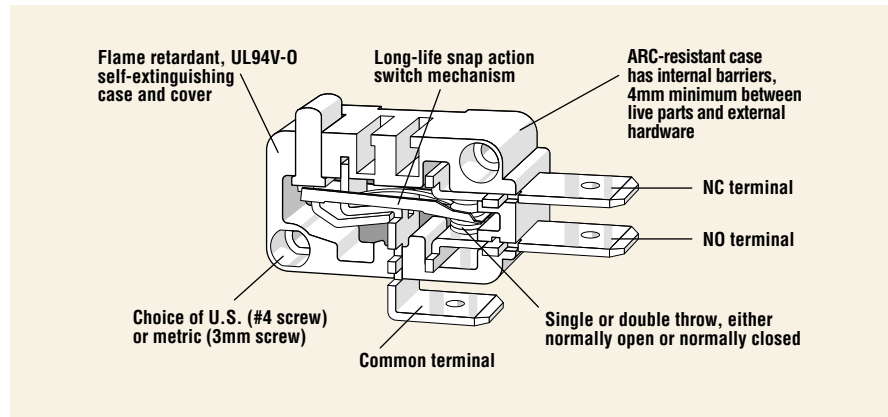

Specifications

Electrical

Temperature Rating:	-40° to +85°C, 150°C or 200°C
Flammability Rating:	UL94V-0

Materials

Case/Cover:	Thermoplastic Polyester (85°C or 150°C) Liquid Crystal Polymer (200°C)
Button:	Thermoplastic Acetal (85°C) Thermoplastic Polyester (150°C) Liquid Crystal Polymer (200°C)
Auxiliary Actuator:	Cold-Rolled Steel (Nickel-Plated)
Terminals:	Brass Copper (25 amp only)
Moving Blade:	Beryllium Copper
Contacts:	Silver Alloy (except KWA and KWB — Gold-Plated)



Dimensions inches (mm)

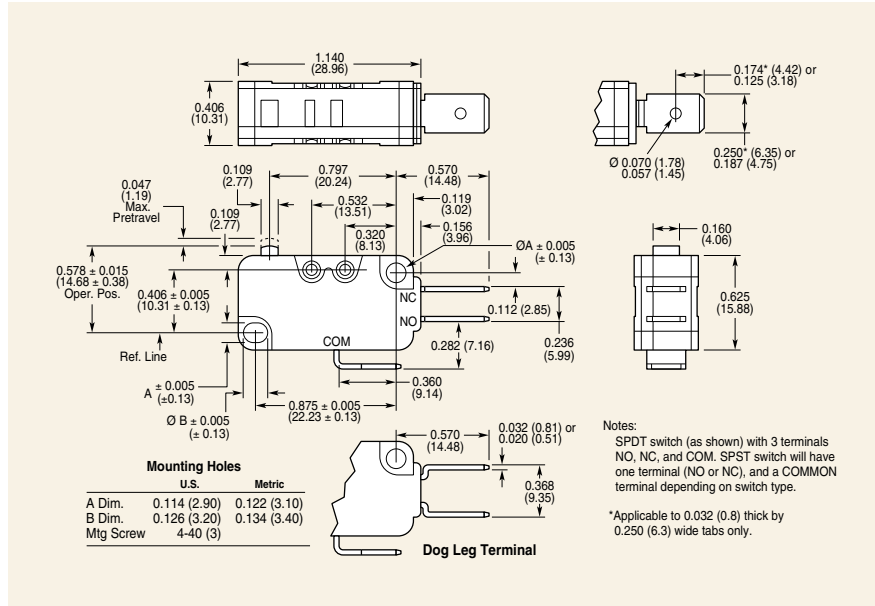

Actuators

Standard type snap over hinged lever and roller actuators are available in choice of two pivot positions. Lengths are dimensioned from centerline of switch upper mounting hole as shown here.

Auxiliary Actuator

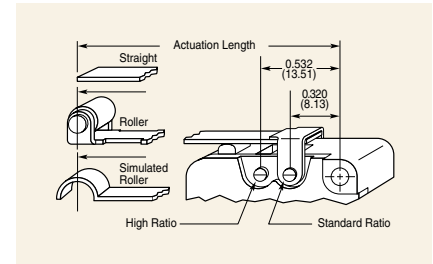

Mounting

Recommended mounting screw size: #4-40 Round head. Recommended torque on screw: 3 inch lbs. max.

Actuator Specifications

Actuator Type	Switch Type	Maximum Operating Force (gms.)					Maximum Pre-Travel inches (mm)	Operating Point* inches (mm)	Minimum Over-Travel inches (mm)	Max. Movement Differential inches (mm)	Actuation Length** inches (mm)
		KWA, KWC, KWE	KWG	KWD, KWJ, KWB, KWF	KWH, KWK, KWM	KWS					
A		25	50	75	150	225	0.047 (1.19)	0.563/0.593 (14.31/15.06)	0.050 (1.27)	0.010 (0.25)	—
B		25	50	75	150	225	0.064 (1.63)	0.621/0.585 (15.78/14.85)	0.051 (1.29)	0.012 (0.31)	0.865 (21.97)
C		14	27	40	80	120	0.128 (3.26)	0.637/0.569 (16.18/14.45)	0.085 (2.16)	0.030 (0.76)	1.400 (35.56)
D		6	12	18	36	54	0.284 (7.22)	0.679/0.527 (17.25/13.38)	0.182 (4.62)	0.051 (1.30)	2.722 (69.14)
E		15	30	44	88	132	0.116 (2.95)	0.634/0.572 (16.11/14.52)	0.074 (1.88)	0.021 (0.54)	1.077 (27.36)
F		8	15	23	45	67	0.230 (5.85)	0.665/0.541 (16.90/13.74)	0.146 (3.71)	0.041 (1.05)	1.612 (40.94)
G		4	7	10	20	30	0.512 (13.01)	0.739/0.467 (18.78/11.86)	0.407 (10.33)	0.091 (2.32)	2.934 (74.52)
J		16	31	46	92	138	0.110 (2.80)	0.758/0.698 (19.26/17.72)	0.088 (2.23)	0.020 (0.51)	1.254 (31.85)
M		9	18	26	52	77	0.200 (5.08)	0.781/0.675 (19.84/17.14)	0.115 (2.92)	0.036 (0.92)	1.466 (37.24)
Q		15	29	43	85	127	0.120 (3.05)	0.852/0.786 (21.65/19.96)	0.096 (2.43)	0.022 (0.56)	1.340 (34.04)
T		8	16	24	47	71	0.218 (5.54)	0.877/0.761 (22.28/19.32)	0.173 (4.39)	0.039 (1.00)	1.552 (39.42)

*Measured above reference line. Refer to dimensional drawing above. **Actuator tolerance ±0.031 inches (0.79mm).

Ordering Information

Series/Prefix	Light	Standard	Current	Code	Force	Rating	Notes
KW	A	25	B	75	50mA	1	
	C	25	D	75	1A	1	
	E	25	F	75	3A	1	
	G	50	H	150	5A	1	
	J	75	K	150	10A	1	
			L	150	15A	3	
			M	150	15A	2	
		S	225	25A	3, 5		

Code	Temperature Rating
A	85°C UL/CUL
B	150°C UL/CUL
C	200°C UL/CUL
D	85°C UL/CUL/VDE*
E	150°C UL/CUL/VDE

*Only available with 15A.

Notes:
 1. cULus rated for 100,000 cycles at 85°C, 150°C, 200°C. VDE rated for 150°C only.
 2. cULus rated for 100,000 cycles at 85°C, 150°C, 200°C. VDE rated for 85°C only.
 3. cULus rated for 100,000 cycles at 85°C only.
 4. Available in 10A and lower, cULus rated for 100,000 cycles at 85°C and 150°C.
 5. Available with 0.250 x 0.032" terminals only.

Code	Terminal Type	inches (mm)
P4	0.062 x 0.032 (1.57 x 0.81) PCB*	
Q	0.187 x 0.020 (4.75 x 0.51) Straight	
R	0.187 x 0.020 (4.75 x 0.51) Dog Leg	
S	0.187 x 0.032 (4.75 x 0.81) Straight	
T	0.187 x 0.032 (4.75 x 0.81) Dog Leg	
V	0.250 x 0.032 (6.35 x 0.81) Straight	
W	0.250 x 0.032 (6.35 x 0.81) Dog Leg	

*PCB terminals are lateral to case only.

Code	Mounting Holes
A	U.S.
B	Metric

Code	Configuration
A	Normally Open
B	Normally Closed
C	Double Throw

Snap Over Actuators		
Code	Type	Actuation Length inches (mm)
A	Button	
B	Straight SR	0.865 (21.97)
C	Straight SR	1.400 (35.56)
D	Straight SR	2.722 (69.14)
E	Straight HR	1.077 (27.36)
F	Straight HR	1.612 (40.95)
G	Straight HR	2.934 (74.52)
J	SIM Roller SR	1.254 (31.85)
M	SIM Roller HR	1.466 (37.24)
Y†	Roller SR	0.810 (20.57)
Q	Roller SR	1.340 (34.04)
W†	Roller HR	1.022 (25.96)
T	Roller HR	1.552 (39.42)

†Available as internal mounting only.